

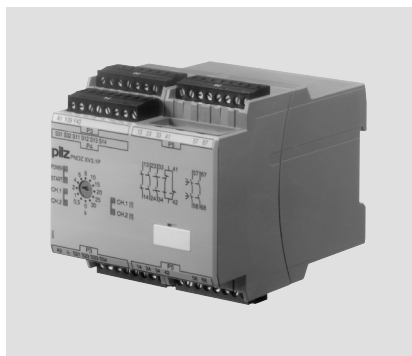



## Up to Category 4, EN 954-1 PNOZ XV3.1P



Safety relay for monitoring E-STOP pushbuttons and safety gates.

### Approvals

PNOZ XV3.1P	
	◆
	◆
	◆

### Unit features

- ▶ Positive-guided relay outputs:
  - 3 safety contacts (N/O), instantaneous
  - 2 safety contacts (N/O), delay-on de-energisation
  - 1 auxiliary contact (N/C), instantaneous
- ▶ Connection options for:
  - E-STOP pushbutton
  - Safety gate limit switch
  - Light barriers
  - Reset button
- ▶ Delay-on de-energisation, fixed or selectable
- ▶ Delay time can be cancelled via reset button
- ▶ LED indicator for:
  - Switch status channel 1/2
  - Supply voltage
  - Reset circuit
- ▶ Plug-in connection terminals (either cage clamp terminal or screw terminal)
- ▶ See order reference for unit types

### Unit description

The safety relay meets the requirements of EN 60204-1 and IEC 60204-1 and may be used in applications with

- ▶ E-STOP pushbuttons
- ▶ Safety gates
- ▶ Light barriers

The max. category the safety contacts can achieve in accordance with EN 954-1 is stated in the technical details.

### Safety features

The relay conforms to the following safety criteria:

- ▶ The circuit is redundant with built-in self-monitoring.
- ▶ The safety function remains effective in the case of a component failure.
- ▶ The correct opening and closing of the safety function relays is tested automatically in each on-off cycle.
- ▶ The transformer is short circuit-proof. An electronic fuse is used on a DC supply.

### Block diagram

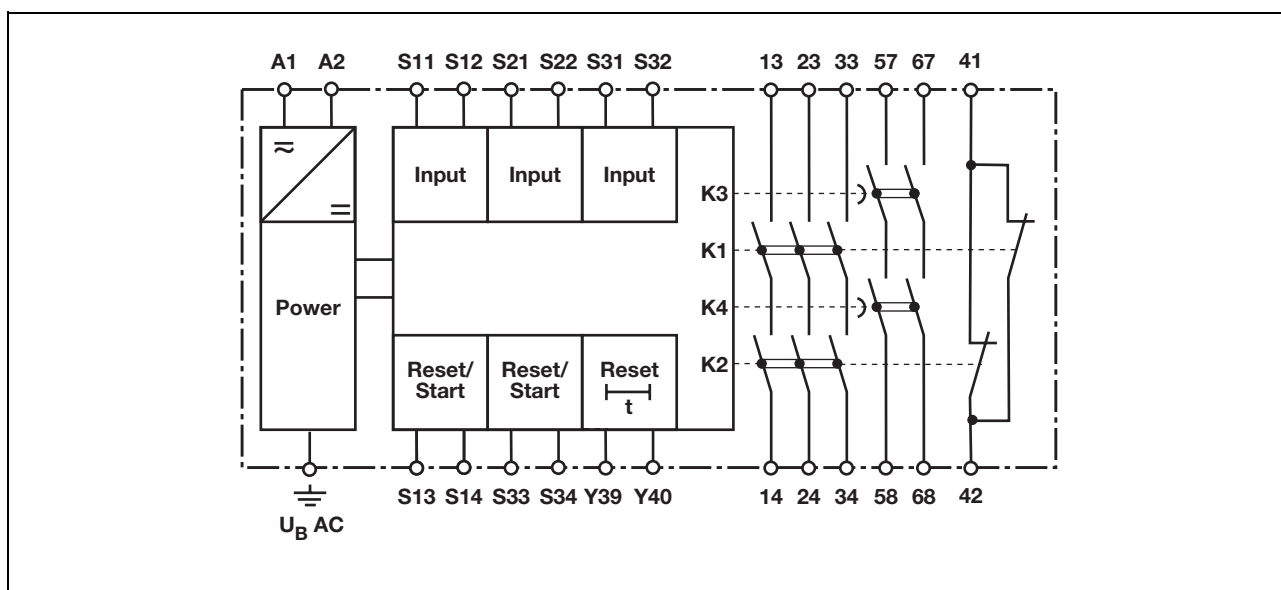

## Up to Category 4, EN 954-1 PNOZ XV3.1P

### Function description

- ▶ Single-channel operation: no redundancy in the input circuit, earth faults in the reset circuit are detected.
- ▶ Dual-channel operation with detection of shorts across contacts: redundant input circuit, detects
  - earth faults in the reset and input circuit,
  - short circuits in the input circuit
- and, with a monitored reset, in the reset circuit too,
  - shorts between contacts in the input circuit.
- ▶ Dual-channel operation without detection of shorts across contacts: redundant input circuit, detects
  - earth faults in the reset and input circuit,
  - short circuits in the input circuit and, with a monitored reset, in the reset circuit too.
- ▶ Automatic start: Unit is active once the input circuit has been closed.
- ▶ Monitored reset: Unit is active once the input circuit is closed and once the reset circuit is closed after the waiting period has elapsed (see technical details).
- ▶ Increase in the number of available contacts by connecting contact expander modules or external contactors/relays.

### Timing diagram

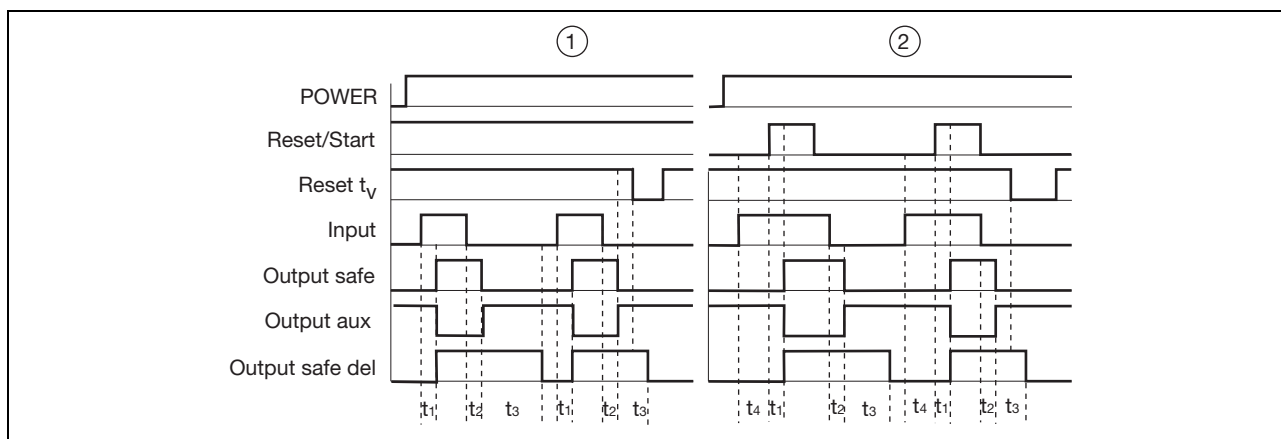

### Key

- ▶ Power: Supply voltage
- ▶ Reset/start: Reset circuit S13-S14, S33-S34
- ▶ Input: Input circuits S11-S12, S21-S22, S31-S32
- ▶ Output safe: Safety contacts, instantaneous 13-14, 23-24, 33-34
- ▶ Output safe del: Safety contacts, delayed 57-58, 67-68
- ▶ Output aux: Auxiliary contacts 41-42
- ▶ ①: Automatic reset
- ▶ ②: Monitored reset
- ▶  $t_1$ : Switch-on delay
- ▶  $t_2$ : Delay-on de-energisation
- ▶  $t_3$ : Delay time
- ▶  $t_4$ : Waiting period

### Wiring

#### Please note:

- ▶ Information given in the “Technical details” must be followed.
- ▶ Outputs 13-14, 23-24, 33-34 are instantaneous safety contacts, outputs 57-58, 67-68 are delay-on de-energisation safety contacts, output 41-42 is an instantaneous auxiliary contact (e.g. for display).
- ▶ To prevent contact welding, a fuse should be connected before the output contacts (see technical details).
- ▶ Calculation of the max. cable runs  $l_{max}$  in the input circuit:

$$l_{max} = \frac{R_{lmax}}{R_l / km}$$

$R_{lmax}$  = max. overall cable resistance (see technical details)

$R_l / km$  = cable resistance/km

- ▶ Use copper wire that can withstand 60/75 °C.
- ▶ Sufficient fuse protection must be provided on all output contacts with capacitive and inductive loads.





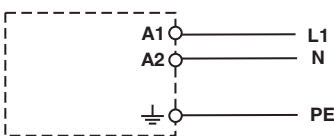
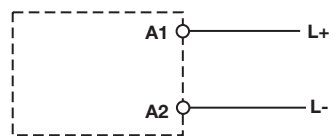

## Up to Category 4, EN 954-1 PNOZ XV3.1P

### Preparing for operation

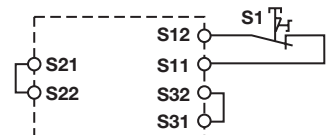
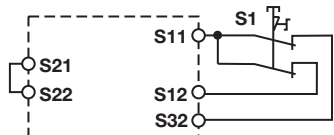
► Supply voltage

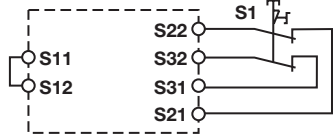
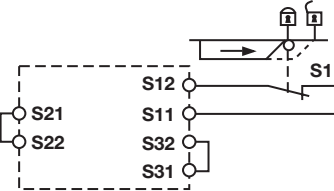
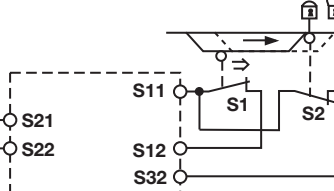

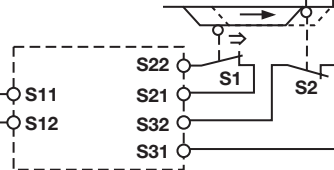
Supply voltage	AC	DC
		

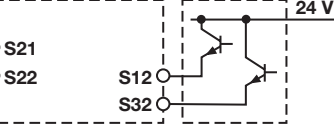
► Input circuit

Input circuit	Single-channel	Dual-channel
E-STOP <b>without</b> detection of shorts across contacts		
E-STOP <b>with</b> detection of shorts across contacts		
Safety gate <b>without</b> detection of shorts across contacts		
Safety gate <b>with</b> detection of shorts across contacts		
Light barrier <b>with</b> detection of shorts across contacts via ESPE		

## Up to Category 4, EN 954-1 PNOZ XV3.1P

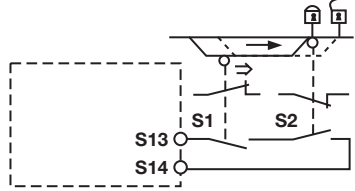
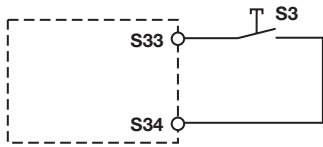
### ▶ Reset circuit

Reset circuit	E-STOP wiring, safety gate	Safety gate (dual-channel)
Automatic reset		
Monitored reset		

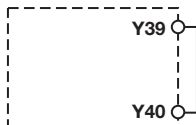
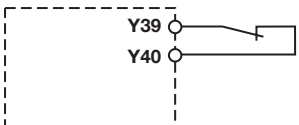

### ▶ Reset

Reset	Link	N/C contact for resetting the delay time
Link or N/C contact		

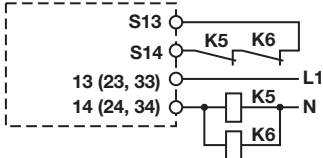
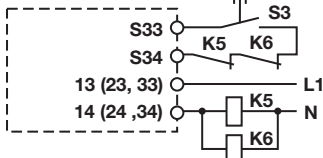
### ▶ Feedback loop

Feedback loop	Automatic reset	Monitored reset
Contacts from external contactors		

### ▶ Key

S1/S2	E-STOP pushbutton/ safety gate switch
S3	Reset button
	Switch operated
	Gate open
	Gate closed

## Up to Category 4, EN 954-1 PNOZ XV3.1P

### Terminal configuration

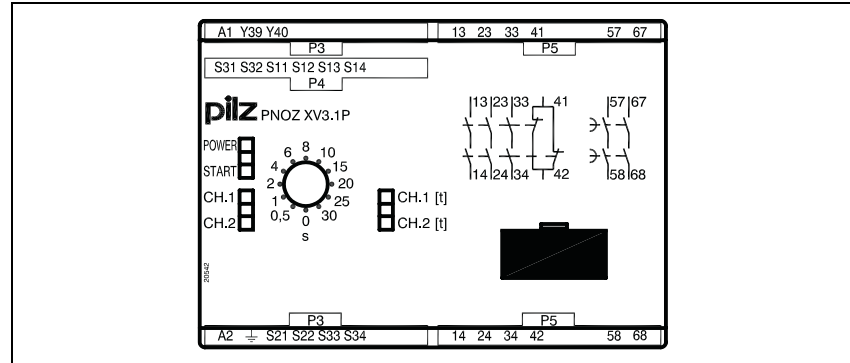

### Installation

- ▶ The safety relay should be installed in a control cabinet with a protection type of at least IP54.
- ▶ Use the notch on the rear of the unit to attach it to a DIN rail.
- ▶ Ensure the unit is mounted securely on a vertical DIN rail (35 mm) by using a fixing element (e.g. retaining bracket or an end angle).

### Dimensions

\* with cage clamp terminals

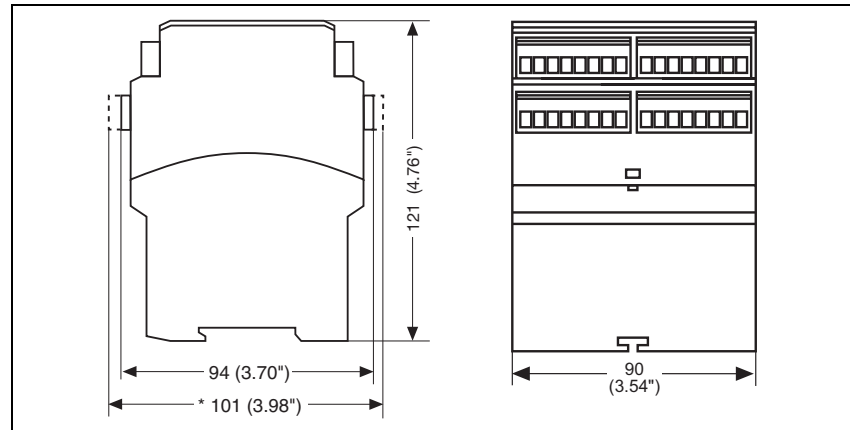

## Up to Category 4, EN 954-1 PNOZ XV3.1P

### Notice

This data sheet is only intended for use during configuration. For installation and operation, please refer to the operating instructions supplied with the unit.

### Service life graph

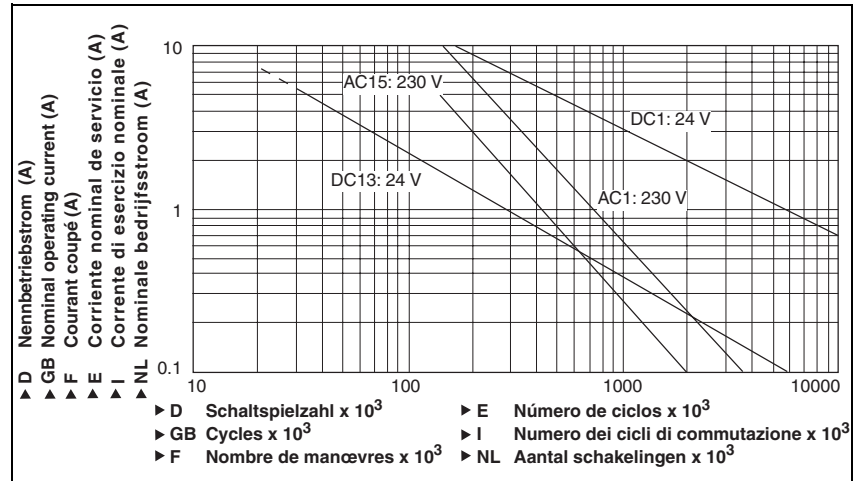

### Technical details

#### Electrical data

Supply voltage	
Supply voltage U <sub>B</sub> DC	<b>24 V</b>
Supply voltage U <sub>B</sub> AC/DC	<b>24 - 240 V</b>
Voltage tolerance	<b>-15 %/+10 %</b>
Power consumption at U <sub>B</sub> AC	<b>8.5 VA</b> Order no.: 777530, 777532, 777538, 787530, 787532, 787538
Power consumption at U <sub>B</sub> DC	<b>4.5 W</b> Order no.: 777520, 777522, 777525, 787520, 787522 <b>5.0 W</b> Order no.: 777530, 777532, 777538, 787530, 787532, 787538
Frequency range AC	<b>50 - 60 Hz</b>
Residual ripple DC	<b>160 %</b>
Voltage and current at input circuit DC: <b>24.0 V</b>	<b>40.0 mA</b> Order no.: 777530, 777532, 777538, 787530, 787532, 787538 <b>50.0 mA</b> Order no.: 777520, 777522, 777525, 787520, 787522
reset circuit DC: <b>24.0 V</b>	<b>40.0 mA</b>
feedback loop DC: <b>24.0 V</b>	<b>3.1 mA</b>
Output contacts in accordance with <b>EN 954-1</b> Category <b>4</b>	Safety contacts (N/O): <b>3</b>
Output contacts in accordance with <b>EN 954-1</b> Category <b>3</b>	Safety contacts (N/O), delayed: <b>2</b>
Category <b>1</b> Order no.: 777520, 777530, 777538, 787520, 787530, 787538	Delay time <30 s Delay time >30 s
	Auxiliary contacts (N/C): <b>1</b>

## Up to Category 4, EN 954-1 PNOZ XV3.1P

### Electrical data

Utilisation category in accordance with <b>EN 60947-4-1</b>	
Safety contacts: AC1 at <b>240 V</b>	$I_{\min}$ : <b>0.01 A</b> , $I_{\max}$ : <b>8.00 A</b> $P_{\max}$ : <b>2000 VA</b>
Safety contacts: DC1 at <b>24 V</b>	$I_{\min}$ : <b>0.01 A</b> , $I_{\max}$ : <b>8.0 A</b> $P_{\max}$ : <b>200 W</b>
Safety contacts, delayed: AC1 at <b>240 V</b>	$I_{\min}$ : <b>0.01 A</b> , $I_{\max}$ : <b>8.0 A</b> $P_{\max}$ : <b>2000 VA</b>
Safety contacts, delayed: DC1 at <b>24 V</b>	$I_{\min}$ : <b>0.01 A</b> , $I_{\max}$ : <b>8.0 A</b> $P_{\max}$ : <b>200 W</b>
Auxiliary contacts: AC1 at <b>240 V</b>	$I_{\min}$ : <b>0.01 A</b> , $I_{\max}$ : <b>8.0 A</b> $P_{\max}$ : <b>2000 VA</b>
Auxiliary contacts: DC1 at <b>24 V</b>	$I_{\min}$ : <b>0.01 A</b> , $I_{\max}$ : <b>8.0 A</b> $P_{\max}$ : <b>200 W</b>
Utilisation category in accordance with <b>EN 60947-5-1</b>	
Safety contacts: AC15 at <b>230 V</b>	$I_{\max}$ : <b>5.0 A</b>
Safety contacts: DC13 at <b>24 V</b> (6 cycles/min)	$I_{\max}$ : <b>7.0 A</b>
Safety contacts, delayed: AC15 at <b>230 V</b>	$I_{\max}$ : <b>5.0 A</b>
Safety contacts, delayed: DC13 at <b>24 V</b> (6 cycles/min)	$I_{\max}$ : <b>7.0 A</b>
Auxiliary contacts: AC15 at <b>230 V</b>	$I_{\max}$ : <b>5.0 A</b>
Auxiliary contacts: DC13 at <b>24 V</b> (6 cycles/min)	$I_{\max}$ : <b>7.0 A</b>
Contact material	<b>AgSnO<sub>2</sub> + 0.2 µm Au</b>
External contact fuse protection to <b>EN 60947-5-1</b>	
Blow-out fuse, quick	
Safety contacts:	<b>10 A</b>
Safety contacts, delayed:	<b>10 A</b>
Auxiliary contacts:	<b>10 A</b>
Blow-out fuse, slow	
Safety contacts:	<b>6 A</b>
Safety contacts, delayed:	<b>6 A</b>
Auxiliary contacts:	<b>6 A</b>
Circuit breaker 24 VAC/DC, characteristic B/C	
Safety contacts:	<b>6 A</b>
Safety contacts, delayed:	<b>6 A</b>
Auxiliary contacts:	<b>6 A</b>
Max. overall cable resistance $R_{l_{\max}}$ input circuits, reset circuits	
single-channel at $U_B$ DC	<b>100 Ohm</b> Order no.: 777520, 777522, 777525, 787520, 787522 <b>150 Ohm</b> Order no.: 777530, 777532, 777538, 787530, 787532, 787538
single-channel at $U_B$ AC	<b>150 Ohm</b> Order no.: 777530, 777532, 777538, 787530, 787532, 787538
dual-channel without detect. of shorts across contacts at $U_B$ DC	<b>120 Ohm</b> Order no.: 777520, 777522, 777525, 787520, 787522 <b>200 Ohm</b> Order no.: 777530, 777532, 777538, 787530, 787532, 787538
dual-channel without detect. of shorts across contacts at $U_B$ AC	<b>200 Ohm</b> Order no.: 777530, 777532, 777538, 787530, 787532, 787538
dual-channel with detect. of shorts across contacts at $U_B$ DC	<b>10 Ohm</b> Order no.: 777520, 777522, 777525, 787520, 787522 <b>20 Ohm</b> Order no.: 777530, 777532, 777538, 787530, 787532, 787538
dual-channel with detect. of shorts across contacts at $U_B$ AC	<b>20 Ohm</b> Order no.: 777530, 777532, 777538, 787530, 787532, 787538

## Up to Category 4, EN 954-1 PNOZ XV3.1P

Times	
Switch-on delay	
with automatic reset typ.	<b>400 ms</b>
with automatic reset max.	<b>550 ms</b> Order no.: 777530, 777532, 777538, 787530, 787532, 787538
	<b>850 ms</b> Order no.: 777520, 777522, 777525, 787520, 787522
with automatic reset after power on typ.	<b>400 ms</b> Order no.: 777520, 777522, 777525, 787520, 787522
	<b>625 ms</b> Order no.: 777530, 777532, 777538, 787530, 787532, 787538
with automatic reset after power on max.	<b>870 ms</b>
with monitored reset typ.	<b>35 ms</b> Order no.: 777530, 777532, 777538, 787530, 787532, 787538
	<b>40 ms</b> Order no.: 777520, 777522, 777525, 787520, 787522
with monitored reset max.	<b>60 ms</b> Order no.: 777530, 777532, 777538, 787530, 787532, 787538
	<b>70 ms</b> Order no.: 777520, 777522, 777525, 787520, 787522
Delay-on de-energisation	
with E-STOP typ.	<b>15 ms</b>
with E-STOP max.	<b>30 ms</b>
with power failure typ.	<b>110 ms</b> Order no.: 777520, 777522, 777525, 787520, 787522
with power failure max.	<b>150 ms</b> Order no.: 777520, 777522, 777525, 787520, 787522
with power failure typ. $U_B = 24 \text{ V DC}$ Order no.: 777530, 777532, 777538, 787530, 787532, 787538	<b>90 ms</b> Order no.: 777530, 777532, 777538, 787530, 787532, 787538
with power failure max. $U_B = 24 \text{ V DC}$ Order no.: 777530, 777532, 777538, 787530, 787532, 787538	<b>250 ms</b> Order no.: 777530, 777532, 777538, 787530, 787532, 787538
with power failure typ. $U_B = 240 \text{ VAC}$	<b>815 ms</b> Order no.: 777530, 777532, 777538, 787530, 787532, 787538
with power failure max. $U_B = 240 \text{ VAC}$	<b>1900 ms</b> Order no.: 777530, 777532, 777538, 787530, 787532, 787538
Recovery time at max. switching frequency 1/s after E-STOP	<b>50 ms +tv</b>
after power failure	<b>200 ms</b> Order no.: 777520, 777522, 777525, 787520, 787522
after power failure on universal power supply	<b>2000 ms</b> Order no.: 777530, 777532, 777538, 787530, 787532, 787538
Delay time $t_V$ : selectable	<b>0.00 s; 0.50 s; 1.00 s; 2.00 s; 4.00 s; 6.00 s; 8.00 s; 10.00 s; 15.00 s; 20.00 s; 25.00 s; 30.00 s</b> Order no.: 777520
	<b>0.10 s; 0.20 s; 0.30 s; 0.40 s; 0.50 s; 0.60 s; 0.70 s; 0.80 s; 1.00 s; 1.50 s; 2.00 s; 3.00 s</b> Order no.: 777522
	<b>0.00 s; 0.50 s; 1.00 s; 2.00 s; 4.00 s; 6.00 s; 8.00 s; 10.00 s; 15.00 s; 20.00 s; 25.00 s; 30.00 s</b> Order no.: 777530
	<b>0.10 s; 0.20 s; 0.30 s; 0.40 s; 0.50 s; 0.60 s; 0.70 s; 0.80 s; 1.00 s; 1.50 s; 2.00 s; 3.00 s</b> Order no.: 777532
	<b>0.00 s; 5.00 s; 10.00 s; 20.00 s; 40.00 s; 60.00 s; 80.00 s; 100.00 s; 150.00 s; 200.00 s; 250.00 s; 300.00 s</b> Order no.: 777538
	<b>0.00 s; 0.50 s; 1.00 s; 2.00 s; 4.00 s; 6.00 s; 8.00 s; 10.00 s; 15.00 s; 20.00 s; 25.00 s; 30.00 s</b> Order no.: 787520
	<b>0.10 s; 0.20 s; 0.30 s; 0.40 s; 0.50 s; 0.60 s; 0.70 s; 0.80 s; 1.00 s; 1.50 s; 2.00 s; 3.00 s</b> Order no.: 787522
	<b>0.00 s; 0.50 s; 1.00 s; 2.00 s; 4.00 s; 6.00 s; 8.00 s; 10.00 s; 15.00 s; 20.00 s; 25.00 s; 30.00 s</b> Order no.: 787530
	<b>0.10 s; 0.20 s; 0.30 s; 0.40 s; 0.50 s; 0.60 s; 0.70 s; 0.80 s; 1.00 s; 1.50 s; 2.00 s; 3.00 s</b> Order no.: 787532
	<b>0.00 s; 5.00 s; 10.00 s; 20.00 s; 40.00 s; 60.00 s; 80.00 s; 100.00 s; 150.00 s; 200.00 s; 250.00 s; 300.00 s</b> Order no.: 787538
Delay time $t_V$ : fixed	<b>3.00 s</b> Order no.: 777525
Repetition accuracy	<b>2 %</b>
Time accuracy	<b>-15 %/+15 % +50 ms</b>
Waiting period with a monitored reset	<b>300 ms</b>
Min. start pulse duration with a monitored reset	<b>30 ms</b>



## Up to Category 4, EN 954-1 PNOZ XV3.1P

Times	
Simultaneity, channel 1 and 2	∞
Supply interruption before de-energisation	<b>20 ms</b> Order no.: 777522, 777525, 777530, 777532, 777538, 787520, 787522, 787530, 787532, 787538 <b>25 ms</b> Order no.: 777520
Environmental data	
EMC	<b>EN 60947-5-1, EN 61000-6-2, EN 61000-6-4</b>
Vibration in accordance with <b>EN 60068-2-6</b>	
Frequency	<b>10 - 55 Hz</b>
Amplitude	<b>0.35 mm</b>
Climatic suitability	<b>EN 60068-2-78</b>
Airgap creepage	<b>VDE 0110-1</b>
Ambient temperature	<b>-10 - 55 °C</b>
Storage temperature	<b>-40 - 85 °C</b>
Protection type	
Mounting (e.g. control cabinet)	<b>IP54</b>
Housing	<b>IP40</b>
Terminals	<b>IP20</b>
Mechanical data	
Housing material	
Housing	<b>PPO UL 94 V0</b>
Front	<b>ABS UL 94 V0</b>
Max. cross section of external conductors with screw terminals	
1 core flexible	<b>0.25 - 2.50 mm<sup>2</sup>, 24 - 12 AWG</b> Order no.: 777520, 777522, 777525, 777530, 777532, 777538
2 core, same cross section, flexible: with crimp connectors, without insulating sleeve	<b>0.25 - 1.00 mm<sup>2</sup>, 24 - 16 AWG</b> Order no.: 777520, 777522, 777525, 777530, 777532, 777538
without crimp connectors or with TWIN crimp connectors	<b>0.20 - 1.50 mm<sup>2</sup>, 24 - 16 AWG</b> Order no.: 777520, 777522, 777525, 777530, 777532, 777538
Torque setting with screw terminals	<b>0.50 Nm</b> Order no.: 777520, 777522, 777525, 777530, 777532, 777538
Max. cross section of external conductors with cage clamp terminals: flexible without crimp connectors	<b>0.20 - 1.50 mm<sup>2</sup>, 24 - 16 AWG</b> Order no.: 787520, 787522, 787530, 787532, 787538
Cage clamp terminals: terminal points per connection	<b>2</b> Order no.: 787520, 787522, 787530, 787532, 787538
Stripping length	<b>8 mm</b> Order no.: 787520, 787522, 787530, 787532, 787538
Dimensions	
Height	<b>101.0 mm</b> Order no.: 787520, 787522, 787530, 787532, 787538 <b>94.0 mm</b> Order no.: 777520, 777522, 777525, 777530, 777532, 777538
Width	<b>90.0 mm</b>
Depth	<b>121.0 mm</b>
Weight	<b>500 g</b> Order no.: 787520, 787522 <b>510 g</b> Order no.: 777520, 777522, 777525 <b>570 g</b> Order no.: 787530, 787532, 787538 <b>580 g</b> Order no.: 777530, 777532, 777538

The standards current on **04/03** apply.

Max. continuous current		
Number of contacts	$I_{max}$ (A) at $U_B$ DC	$I_{max}$ (A) at $U_B$ AC
1	<b>8.00 A</b>	<b>8.00 A</b> Order no.: 777530, 777532, 777538, 787530, 787532, 787538
2	<b>7.80 A</b>	<b>7.80 A</b> Order no.: 777530, 777532, 777538, 787530, 787532, 787538
3	<b>6.50 A</b>	<b>6.50 A</b> Order no.: 777530, 777532, 777538, 787530, 787532, 787538

## Up to Category 4, EN 954-1 PNOZ XV3.1P

### Max. continuous current

4	5.50 A	5.50 A Order no.: 777530, 777532, 777538, 787530, 787532, 787538
5	5.00 A	5.00 A Order no.: 777530, 777532, 777538, 787530, 787532, 787538

### Order reference

Type	Features	Terminals	Order no.
PNOZ XV3.1P C	24 VDC	30 s selectable Cage clamp terminals	787 520
PNOZ XV3.1P	24 VDC	30 s selectable Screw terminals	777 520
PNOZ XV3.1P C	24 VDC	3 s selectable Cage clamp terminals	787 522
PNOZ XV3.1P	24 VDC	3 s selectable Screw terminals	777 522
PNOZ XV3.1P	24 VDC	3 s fixed Screw terminals	777 525
PNOZ XV3.1P C	24 - 240 VAC/DC	30 s selectable Cage clamp terminals	787 530
PNOZ XV3.1P	24 - 240 VAC/DC	30 s selectable Screw terminals	777 530
PNOZ XV3.1P C	24 - 240 VAC/DC	3 s selectable Cage clamp terminals	787 532
PNOZ XV3.1P	24 - 240 VAC/DC	3 s selectable Screw terminals	777 532
PNOZ XV3.1P C	24 - 240 VAC/DC	300 s selectable Cage clamp terminals	787 538
PNOZ XV3.1P	24 - 240 VAC/DC	300 s selectable Screw terminals	777 538